

PRICE ONE DOLLAR

RCA CATHODE-RAY OSCILLOSCOPE

Type WO-33A

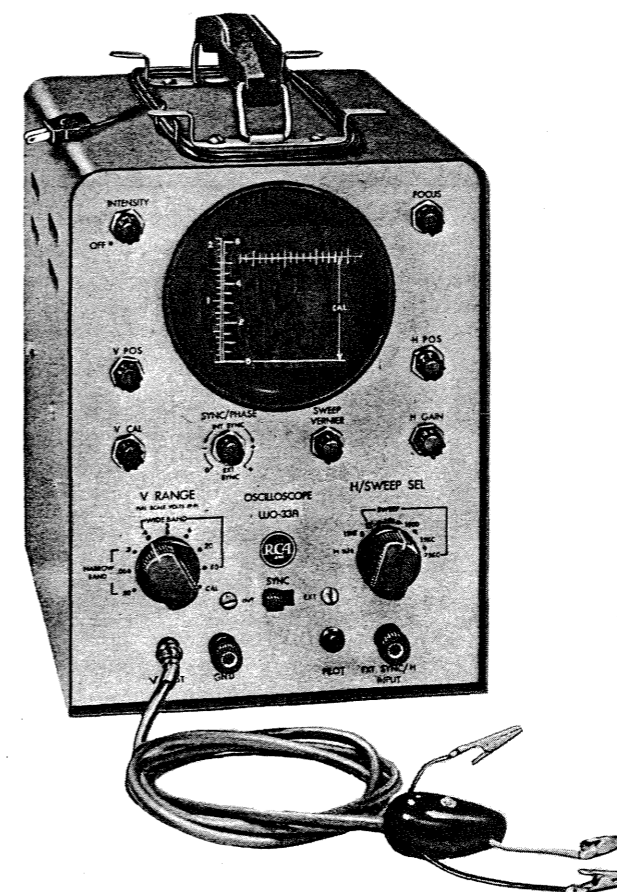

- Specifications
- Operation
- Applications
- Maintenance



RADIO CORPORATION of AMERICA

ELECTRON TUBE DIVISION
ELECTRONIC INSTRUMENTS

HARRISON, N. J.
CAMDEN, N. J.

Safety Precautions

The metal case of this instrument is connected to the ground of the internal circuit. For proper operation, the ground terminal of the instrument should always be connected to the ground of the equipment under test. The WG-349A Direct/Low-Capacitance Probe and Cable has a shield throughout its entire length which is connected to the instrument ground and case.

Care should be exercised to avoid striking the cathode-ray tube or subjecting it to more than moderate pressure in handling. Because the tube contains a high vacuum, implosion might result in injury from flying glass.

An important point to remember is that there is always danger inherent in testing electrical equipment which operates at hazardous voltages. Therefore, the operator should thoroughly familiarize himself with the equipment under test before working on it, bearing in mind that high voltages may appear at unexpected points in defective equipment. Additional precautions which experience in the industry has shown to be important are listed below.

1. It is good practice to remove power before connecting test leads to high-voltage points. If this is impractical, be especially careful to avoid acci-

dental contact with equipment racks and other objects which can provide a ground. Working with one hand in your pocket and standing on a properly insulated floor lessens the danger of shock.

2. Filter capacitors may store a charge large enough to be hazardous. Therefore, discharge filter capacitors before attaching test leads.

3. Remember that leads with broken insulation provide the additional hazard of high voltages appearing at exposed points along the leads. Check test leads for frayed or broken insulation before working with them.

4. To lessen the danger of accidental shock, disconnect test leads immediately after test is completed.

5. Remember that the risk of severe shock is only one of the possible hazards. Even a minor shock can place the operator in hazard of more serious risks such as a bad fall or contact with a source of higher voltage.

6. The experienced operator continuously guards against injury and does not work on hazardous circuits unless another person is available to assist in case of accident.

ITEMS

Supplied with WO-33A

Direct/Low-Capacitance Probe and Cable	Type No. WG-349A
1 6BK7A	2 12AT7
1 6C4	1 6BR8
	1 6X4
	1 RCA 3AQPI
Instruction Booklet	

Available on Separate Order

For rf applications from 500 Kc to 250 Mc:
Demodulator Probe Type No. WG-350A

Devices or arrangements shown or described herein may use patents of RCA or others. Information contained herein is furnished without responsibility by RCA for its use and without prejudice to RCA's patent rights.

Cathode-Ray Oscilloscope

Type WO-33A

Contents

	Page No.
Safety Precautions	2
Items Supplied with WO-33A	2
Description	4
Specifications	5
Functions of Controls and Terminals	6
Operation	8
Initial Procedure	8
Vertical-Amplifier Operation	8
Horizontal-Amplifier Operation	8
Sweep-Oscillator Operation	8
Use of WG-349A Probe	9
Calibration and Voltage Measurement	9
Applications	11
Analyzing Composite Television Waveforms	11
Alignment	14
Schematic Diagram of WO-33A	12-13
General Applications	18
Square-Wave Testing of Audio Amplifiers	18
Phase-Shift Measurements	18
Frequency Measurements	19
Industrial Applications	20
Engine-Pressure Analysis	20
Vibration Measurements	20
Maintenance	21
General	21
Astigmatism Adjustment	21
Vertical Attenuator Alignment	21
Internal Calibrator Control Adjustment	21
Repair Service	21
Replacement Parts List	22-23
Warranty	23

Description

The RCA WO-33A is a 3-inch oscilloscope designed for "on-location" and service-shop use in servicing color and black-and-white television receivers, Hi-Fi equipment, PA and sound reinforcing systems, broadcast station and remote equipment, communications and industrial electronic equipment.

A novel feature of the WO-33A is the Vertical Input Attenuator which automatically switches the amplifier from Wide Band to Narrow Band when in the three highest gain positions.

Another important feature of the WO-33A is the exceptionally high gain in its vertical amplifier. There is enough sensitivity to provide a useful display of signals from low-level microphones, phono-pickups and other weak signals found in radio/TV receivers, audio amplifiers, etc.

A voltage-calibrated, frequency-compensated vertical-input attenuator, an internal calibrating-voltage source, and a graph screen scaled directly in volts make it possible to use the WO-33A as a visual voltmeter. The unique system of calibrating the graph screen provides for scaling voltages directly from the screen. The measurement procedure is very similar to that employed with a vacuum-tube voltmeter. A calibrating voltage is automatically applied to the vertical amplifier when the bandwidth control is set to the calibration position. This switch also disconnects internally the input and attenuator circuits, making it unnecessary to remove leads and probes from the external circuit under test. These unique facilities make voltage calibration and measurement a simple, almost automatic procedure.

The sweep-frequency control is continuously adjustable from 15 cps to 75 Kc. The sweep oscillator has excellent stability at high sweep rates, a fast retrace, and adequate linearity throughout its frequency range. The over-all frequency range of the oscillator is divided into four basic ranges; a vernier adjustment, which overlaps the basic sweep ranges, provides exact adjustment of the sweep frequency. The amount of sync signal fed to the sweep oscillator may be adjusted by means of a front-panel

control. Sweep synchronization is exceptionally stable throughout the sweep range of the oscillator.

A phase control is provided for varying the phase of the internal sweep voltage when the "LINE" position of the H/SWEEP SEL control is used, enabling the WO-33A to be phased with an external line-frequency sweep oscillator.

To facilitate its use, the WO-33A is equipped with a specially designed single-unit probe and input cable. This accessory, the WG-349A Direct/Low-Capacitance Probe and Cable, is provided with a blue input lead and a yellow input lead. When the blue input is used, the test signal is fed directly to the vertical-input terminal. When the yellow input is used, a special high-impedance circuit in the probe is connected in series with the test point and the scope. This high-impedance circuit presents an overall input resistance of 10 megohms and an input capacitance of approximately 10 $\mu\mu\text{f}$ to the test circuit. This feature reduces circuit-loading effects and permits use in circuits which would not function properly if loaded down by a conventional oscilloscope.

The WO-33A can be used to trouble-shoot and signal trace all sections of both black-and-white and color-TV receivers. The voltage-calibrating facilities, wide band-pass, and high-impedance input characteristics make possible observations and measurements of color-burst signals and other critical, high-frequency waveshapes in circuits which are sensitive to loading effects.

The size and weight of the WO-33A make it an especially portable instrument, useful in such applications as industrial maintenance and trouble-shooting, general waveform analysis, adjustment of radio receivers and transmitters, square-wave and general testing of audio equipment, peak-to-peak voltage measurements, and observation of vacuum-tube characteristics. The WO-33A is a versatile and reliable instrument, well suited to applications which require a dependable oscilloscope.

Specifications

NOTE: Performance figures are for a line voltage of 117 volts, 60 cps.

Electrical

Frequency Response:

Vertical Amplifier:	
Wide-Band Positions (5.5 cps to 5.5 Mc)	flat within -3 db
High-Sensitivity Positions:	
20 cps to 150 Kc	flat within -3 db
3 cps to 1.5 Mc	flat within -6 db
Horizontal Amplifier (3.5 cps to 350 Kc)	flat within -6 db

Deflection Sensitivity:

Vertical Amplifier:					
	(Wide-Band) Positions		(High-Sensitivity) Positions		
	rms	p-p	rms	p-p	
At V INPUT connector	0.10	0.3	.003	0.01	volt/in
With WG-349A Blue Lead	0.10	0.3	.003	0.01	volt/in
With WG-349A Yellow Lead	1.0	3.0	.03	0.1	volt/in
Horizontal Amplifier (at H INPUT terminal)					0.9 rms volt/in
Rise Time (Vertical Amplifier):					
5.5-Mc Positions					0.1 μsec

Input Resistance and Capacitance:

Vertical Amplifier:	
At V INPUT connector	1 megohm shunted by approx. 50 $\mu\mu\text{f}$
With WG-349A Blue Lead	1 megohm shunted by approx. 90 $\mu\mu\text{f}$
With WG-349A Yellow Lead	10 megohms shunted by approx. 10 $\mu\mu\text{f}$
Horizontal Amplifier (at H INPUT terminal)	10 megohms
EXT SYNC Input Terminal	250 K to 55 K

Sweep Oscillator:

Frequency Range (continuously adjustable)	15 cps to 75 Kc
Sync	External; \pm Internal
Sync Range	To 4.5 Mc

Maximum AC Input Voltage (at Lo-Cap Probe):

(In presence of 400 volts dc)	600 p-p volts
-------------------------------	---------------

Phase-Control Range

	0 to 160 degrees
--	------------------

Power Requirements:

Voltage	105-125 volts, 50-60 cps
Average Power Consumption	50 watts

Tube Complement

1-6BR8	2-12AT7	1-6C4
1-6BK7A	1-6X4	1-3AQ1

Mechanical

Height	8 $\frac{3}{4}$ "	Length	10 $\frac{1}{2}$ "
Width	6 $\frac{1}{2}$ "	Weight	14 lbs

Functions of Controls and Terminals

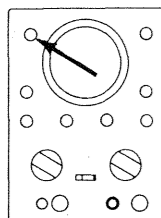

OFF-INTENSITY — Applies power to the instrument and increases intensity of the trace on the screen of the cathode-ray tube when control is turned clockwise from "OFF" position.

V-CAL — Adjusts sensitivity, or calibrates vertical amplifier to correspond with positions on V RANGE switch.

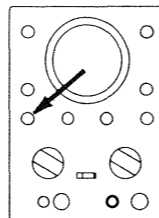

FOCUS — Adjusts the sharpness of the trace. Normally requires adjustment when setting of the INTENSITY control is changed.

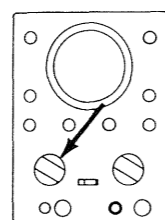
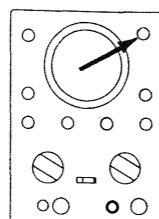

V RANGE — In "CAL" position, disconnects vertical amplifier from input connector, and supplies a calibrating voltage which should be adjusted with "V-CAL" control to full-screen deflection. Adjusts overall sensitivity of vertical amplifier in "3-to-1" steps. Automatically changes bandwidth of vertical amplifier when going from ".2" to ".6" positions.

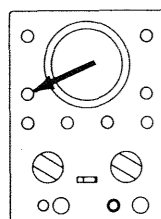

V POS — Adjusts vertical position of trace.

V INPUT — Feeds the input signal to the vertical amplifier through the attenuator circuits.

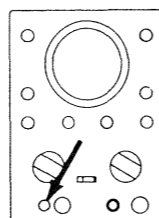

H POS — Adjusts horizontal position of trace.

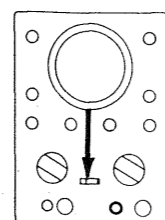
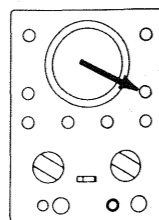

SYNC — Selects the source of the synchronizing signal.

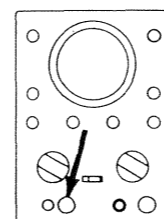

GND — Connected directly to case and chassis.

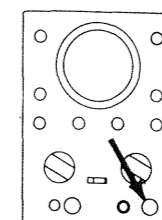

EXT SYNC/H INPUT — An external synchronizing signal for the sweep oscillator should be connected between this terminal and the ground terminal. The "SYNC" switch should be set to "EXT". An external signal for the horizontal amplifier should also be connected

between this terminal and the ground terminal and the H/SWEEP SEL control set to "H IN". A positive-going signal will cause the spot to deflect to the right; a negative-going signal will cause the spot to deflect to the left.

H/SWEEP SEL — Selects the frequency range of the sweep oscillator. Used in conjunction with the SWEEP VERNIER control. Also switches the Horizontal Amplifier to "H INPUT" or to a sine-wave sweep voltage of power-line frequency.

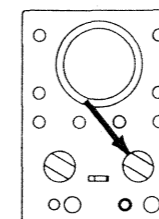

SWEEP VERNIER — Provides continuous control of the oscillator sweep frequency over the range selected by the SWEEP control. Also provides overlap of the SWEEP control positions.

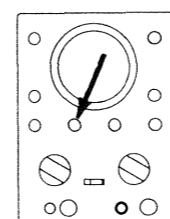
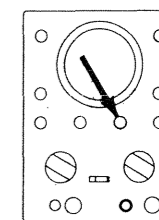

SYNC/PHASE — Controls the amplitude of the synchronizing voltage applied to the grid of the sweep oscillator; should be adjusted to minimum setting necessary to lock pattern in a stationary position. Works zero-center for internal sync. Adjusts external sync by regular clockwise rotation. Also controls phase of the sinusoidal sweep voltage when the H/SWEEP SEL switch is in the "LINE" position.

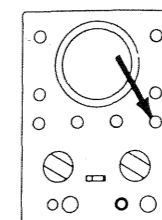

H GAIN — Adjusts the gain of the horizontal amplifier and varies the width of the horizontal trace. Does not provide enough control to reduce trace length to zero.

Operation

To become familiar with the operation of the WO-33A Oscilloscope, it is recommended that the operator follow the procedure outlined below in the order given. The section "Function of Controls and Terminals" on pages 6 and 7 of the block diagram on page 20 will also be helpful.

Initial Procedure

1. Connect the power cord at the rear of the instrument to an ac outlet supplying 105-125 volts at 50-60 cps.
2. Turn the INTENSITY control clockwise from the "OFF" position and wait a few seconds for the instrument to warm up.
3. Rotate the INTENSITY control farther clockwise until either a spot or a horizontal line appears on the screen. The spot or line should increase in brilliance as the control is turned clockwise. NOTE: Do not allow a small spot of high brilliance to remain stationary on the screen for an appreciable length of time because discoloration or burning of the screen may result.
4. Adjust the FOCUS control for an image of maximum sharpness.
5. Turn the H/SWEEP SEL control to the "H IN" position. In this position, without an external signal being applied to the H-INPUT terminals, no sweep voltage appears at the horizontal-deflecting electrodes of the cathode-ray tube and, therefore, only a spot will appear on the screen.
6. Position the spot in the center of the screen by adjusting the V POS and H POS controls.

Vertical-Amplifier Operation

1. Connect the WG-349A probe connector to the V INPUT connector. Set the V RANGE control to "CAL". The screen should now display a vertical trace, indicating that a signal has been applied to the vertical-deflecting electrodes of the cathode-ray tube.
2. Change the height of the vertical trace by rotating the V CAL control.
3. Set the H/SWEEP SEL to the dot between 15 and 150.

4. Lock in as described under "Sweep Oscillator Operation".

Horizontal-Amplifier Operation

1. Apply an ac signal of from 1 to 3 volts to the EXT SYNC/H INPUT terminal. An audio-frequency generator or a 60-cps line signal may be used as the source. Set the H/SWEEP SEL to "H IN", set the V RANGE control to 60, and set the H GAIN control fully clockwise. A horizontal line will appear on the screen, indicating that an external signal has been applied to the horizontal-deflecting electrodes of the cathode-ray tube.
2. Disconnect the lead from the voltage source. The horizontal line will be replaced by a spot.
3. Turn the H/SWEEP SEL to the "LINE" position. A horizontal line should appear. NOTE: When the H/SWEEP SEL switch is set to the "LINE" position, part of the power-line signal is fed internally to the horizontal amplifier, providing a sinusoidal horizontal-deflection voltage of power-line frequency. The SYNC/PHASE control can be used to adjust the phase of the internal sinusoidal sweep.
4. Turn the H/SWEEP SEL control to any of the sweep positions. The sawtooth output from the sweep oscillator is applied internally to the horizontal amplifier and a linear horizontal trace appears on the screen.

Sweep-Oscillator Operation

1. Adjust the H/SWEEP SEL and the SWEEP VERNIER control to give a sweep of approximately power-line frequency. Connect the ground lead from the WG-349A to the ground side of an ac-voltage source. An audio-frequency generator or a power-line signal can be used as a source. With the cable connector of the WG-349A attached to the V INPUT connector of the WO-33A, connect the blue lead to the other side of the low-voltage source. Adjust the SWEEP VERNIER control for a single cycle on the oscilloscope screen. Rotate the SYNC/PHASE control and note that it should be adjusted to a minimum position necessary to lock pattern in a stationary position.

2. With a single pattern on the screen, notice whether the pattern drifts across the face of the tube. Horizontal drift indicates that the SYNC/PHASE control should be rotated toward its clockwise or counterclockwise limits or that the SWEEP VERNIER control should be adjusted until the waveform is locked in.

3. Connect the WG-349A connector to an external signal of a different frequency.

4. Set the H/SWEEP SEL control to "H IN" and adjust the H/SWEEP and SWEEP VERNIER controls to produce a suitable sweep frequency. Apply a synchronizing voltage from the external signal to the EXT SYNC terminal. Set the SYNC switch to "EXT". Adjust the SYNC/PHASE control until the pattern locks in on the oscilloscope screen.

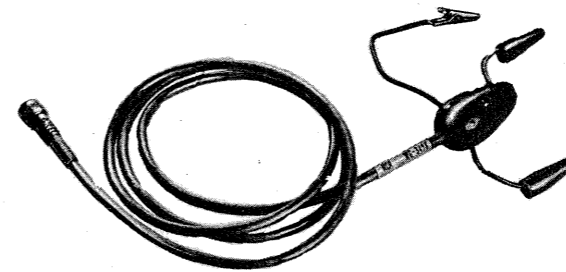

Figure 1. WG-349A direct/low-capacitance probe and cable supplied with WO-33A

Use of the WG-349A Direct/Low-Capacitance Probe

The WG-349A Direct/Low-Capacitance Probe and Cable is designed especially for use with the WO-33A Oscilloscope. This single-unit probe is equipped with two clips from the probe housing which permits using the probe for direct measurements or for connecting a built-in high-impedance network in series with the test point and the probe cable. When the yellow lead is used, the input capacitance of the cable and scope is reduced to 10 μf and the input resistance is raised to 10 megohms. These high-impedance characteristics permit use of the WO-33A in high-impedance circuits, such as those found in TV sync-separator and video-amplifier stages, which would not operate properly if loaded down by a conventional scope probe and cable.

Whenever the probe is used in its low-capacitance position, however, the signal is attenuated by a factor of ten. Therefore, when voltage measurements

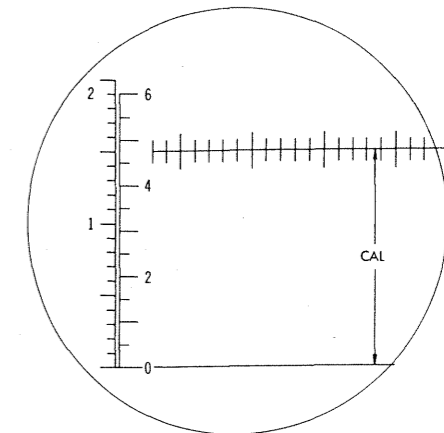

Figure 2. WO-33A graph screen with voltage scales

are made, the indicated voltage should be multiplied by 10.

Calibration and Voltage Measurement

Special facilities on the WO-33A provide for simple and quick voltage calibration of the vertical amplifier and the cathode-ray tube screen. When the oscilloscope has been calibrated as indicated below, the graph-screen scales can be used to measure the deflection amplitude of a displayed waveshape directly in volts.

The green-graph screen has two vertical scales, as shown in Figure 2. The scale used depends upon the setting of the V RANGE control.

Calibration is accomplished as follows:

1. Set the V RANGE control to "CAL".
2. Adjust the V POS and V CAL controls for enough vertical deflection to fill the graph screen between the two horizontal lines indicated by the "CAL" arrow on the side of the graph screen. The WO-33A is now calibrated.

When the V RANGE control is set to "CAL", the probe, cable, and input attenuator circuits in the scope are automatically disconnected from the vertical amplifier and an internal calibrating voltage is applied. The H/SWEEP SEL control may be set to any position during calibration. A straight vertical line is obtained by setting this control to "H IN". A sinusoidal waveshape is obtained when the H/SWEEP SEL is set to any other position.

Calibration will hold for both the wide band and narrow bandwidth positions. After calibration, an input signal may be read directly in peak-to-peak volts by measuring the vertical deflection against the correct graph-screen scale.

Example: It is desired to simultaneously display and measure the peak-to-peak voltage amplitude of the horizontal driving pulse at the grid pin of the horizontal-deflection-output stage in a TV receiver. Procedure is as follows:

1. Set the bandwidth control to "CAL" and set the H/SWEEP SEL to "H IN".
2. Adjust the V CAL control for exactly full scale vertical deflection as measured on the graph screen. Adjust the V POS control so that the bottom of the trace rests on the base-scale line and the top of the trace rests on the upper horizontal line.
3. The WO-33A is now calibrated.

4. Connect the ground lead from the WG-349A to the TV chassis. Connect the blue probe clip to the appropriate tube-socket pin.

5. Set the V RANGE control to a position which gives the desired on-screen deflection of the waveshape.

6. Lock in the waveshape as described under "Sweep Oscillator Operation".

7. Adjust the V POS control to position the bottom of the trace on the graph-screen base line.

8. Read the peak-to-peak voltage amplitude of the waveshape from the appropriate scale on the graph-screen. The peak-to-peak voltage is read from the scale point opposite the top of the waveshape.

NOTE: If the WG-349A is used in its low-capacitance position, an attenuation factor of 10 is introduced and it will, therefore, be necessary to multiply the voltage reading by 10 to obtain the correct peak-to-peak voltage amplitude.

Applications

Successful servicing and maintenance of black-and-white and color-television receivers requires special techniques, not usually employed in the servicing of other electronic equipment. The general complexity and variety of circuits used in modern television receivers requires a great deal of knowledge on the part of the service technician and demands that test equipment be used properly.

The oscilloscope is of especial importance in the servicing of color receivers. A good television-service oscilloscope, such as the RCA WO-33A, may be used in signal tracing in every section of the receiver; the scope may also be used for making peak-to-peak voltage measurements in such important sections of the receiver as the sync and deflection circuits and in the video, chrominance, and luminance sections of color-TV receivers. In alignment work, where video, chrominance, and luminance circuit adjustments must be made to produce the desired waveshape, the oscilloscope is indispensable. The WO-33A may be used in all these applications.

Signal-tracing means tracing the television signal through various sections of the television receiver to determine how circuits are functioning in terms of the shape and voltage value of the waveform. As the signal passes from one stage to another in the receiver, the shape of the waveform may be altered,

and the height, or voltage amplitude of the waveform may be changed. Whenever possible, the WG-349A probe should be used in the "LOW CAP" position for signal tracing the video amplifier and chrominance circuits because of the low input capacitance and consequent negligible loading of the circuit under test. When the WO-33A is calibrated as described under "Operation", it is possible to simultaneously read the voltage value and observe the shape of the waveform. The process of signal tracing is thus speeded up and it is possible to ascertain a circuit condition quickly.

NOTE: The applications described here apply both to color and to black-and-white receivers.

Analyzing Composite Television Waveforms

Probably the most important waveform encountered in television service work is the composite video waveform consisting of the video signal, the blanking pedestals, and the sync pulses. Photographs of the composite video signal are shown in Figures 3 and 4. The photographs are oscilloscope traces, and show what the composite video signal looks like as it proceeds through the video amplifier of a television receiver.

The television service technician should devote some time to the study of such waveforms by setting up a television receiver known to be in good operating condition and noting the waveforms on the WO-33A at various points in the video amplifier. Traces similar to those shown in Figures 3 and 4 may be obtained on the WO-33A as follows:

(Continued on page 14)

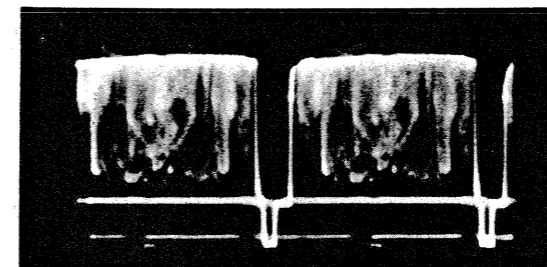

Figure 3. Horizontal-sync pulse in composite signal

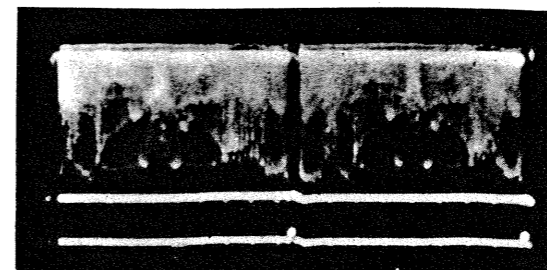

Figure 4. Vertical-sync pulse in composite signal

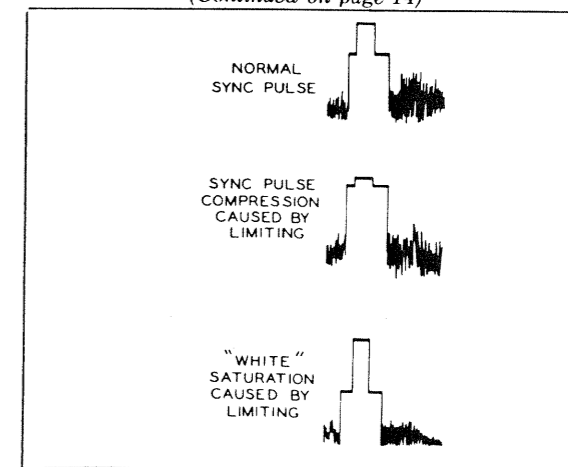
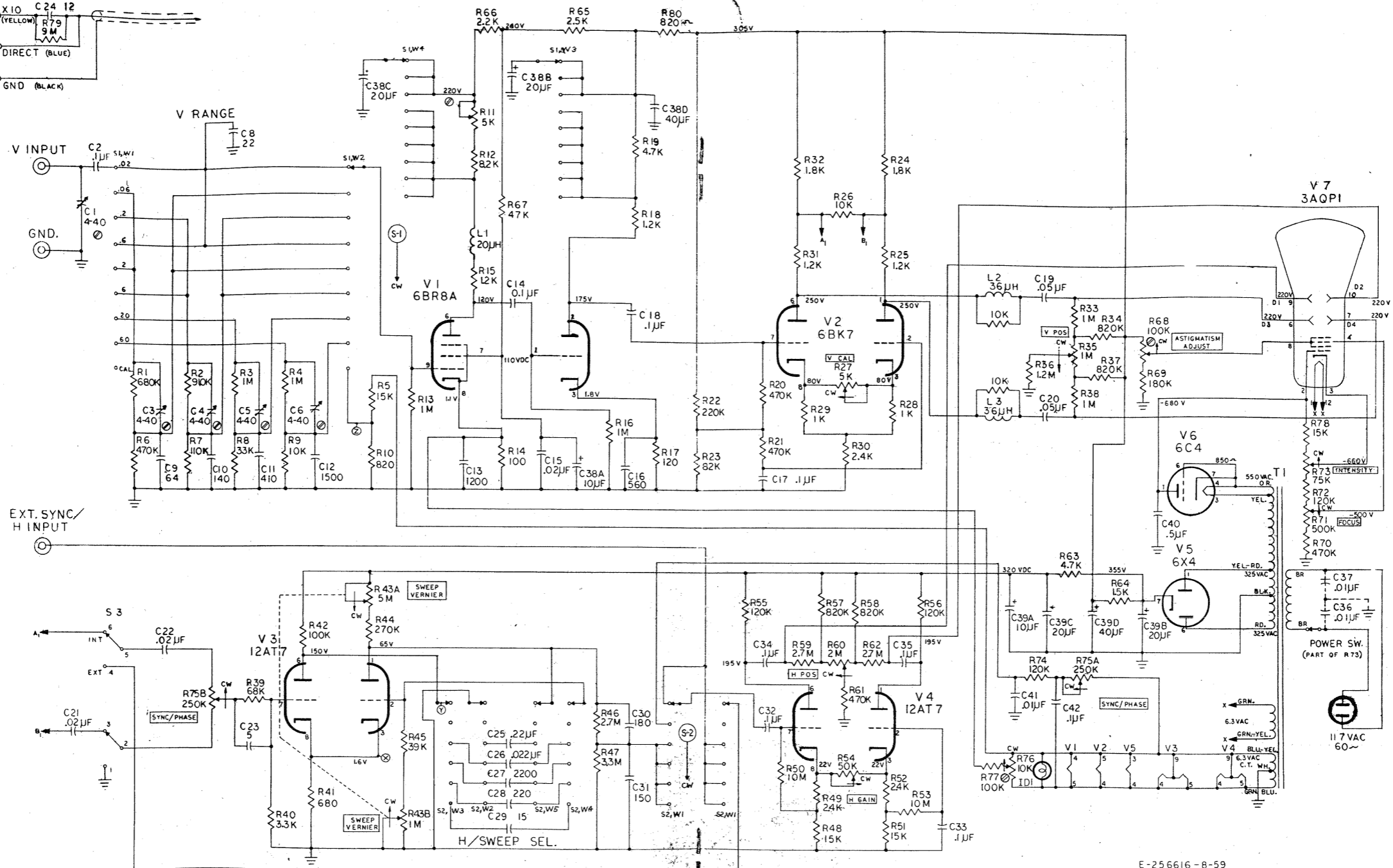
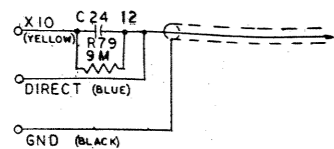

Figure 5. Sync-pulse compression

MULTIPLIER PROBE



EXT. SYNC/
H INPUT

NOTES
 ALL CAPACITORS IN μJF , UNLESS OTHERWISE SPECIFIED.
 ALL RESISTORS IN OHMS.
 ALL VOLTAGES POSITIVE FROM GROUND, AND MEASURED WITH A VOLTOHMIST*
 SWITCHES S-1 AND S-2 SHOWN IN MAXIMUM CCW POSITION INSTRUMENTS WITH SERIAL NO.'S 1001 THRU 2300 HAVE TWO 0.01 μF DISC CAPACITORS BETWEEN THE AC LINE AND CASE GROUND

V RANGE FULL SCALE VOLTS (P-P)	S-1 POSITION	RANGE
0.02	1 (CCW MAX)	NARROW BAND
0.06	2	
0.2	3	
0.6	4	WIDE BAND
2.0	5	
6.0	6	
20	7	
60	8	
CAL	9	

H SWEEP SEL. SW. S-2 POSITION	RANGE
1 (CCW MAX)	HOR. IN. LINE
2	15-150
3	150-1500
4	1500-15KC
5	15KC-75KC
6	

SYNC. SW. S-3 POSITION	RANGE
RIGHT	EXT.
LEFT	INT.

E-256616-8-59

*TRADE-MARK "VOLTOHMIST" REG. U.S. PAT. OFF.







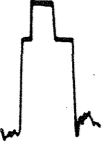

NORMAL HORIZONTAL PULSE	CIRCUIT FAULT	HORIZONTAL PULSE DISTORTION	OVERALL FREQUENCY RESPONSE OF RECEIVER	EFFECT ON PICTURE
	NORMAL CIRCUIT			PICTURE NORMAL
	LOSS OF HIGH FREQUENCIES			LOSS OF PICTURE DETAIL
	EXCESSIVE HIGH-FREQUENCY RESPONSE, NON-LINEAR PHASE SHIFT			FINE VERTICAL BLACK & WHITE STRIATIONS FOLLOWING A SHARP CHANGE IN PICTURE SHADING
	LOSS OF LOW FREQUENCIES (IN THE RANGE ABOVE 15 OR 20 KC)			CHANGE IN SHADING OF LARGE PICTURE AREAS; SMEARED PICTURE.

Figure 6. Sync-pulse distortion

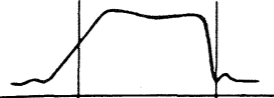
(Continued from page 11)

1. Tune the television receiver to a television signal.
2. Rotate the INTENSITY control on the WO-33A clockwise. Set the SYNC control to "INT". Set the INTENSITY and FOCUS controls for the desired brightness and best focus.
3. Connect the WG-349A probe and cable connector to the V INPUT connector. Connect the ground lead to the receiver chassis. Connect the yellow probe clip to the grid terminal of the picture tube socket. It is not necessary that the picture tube be connected for this test.
4. Set the V RANGE switch and the V CAL control for a pattern of convenient height.
5. To obtain the horizontal-sync pulse on the WO-33A screen, set the H/SWEEP SEL control to the 1500 • 15 Kc position. Adjust the SYNC/PHASE control, if necessary, to obtain lock-in on the sync pulse, and adjust the SWEEP VERNIER control so that two complete waveforms appear on the screen. To obtain the vertical-sync pulse, set the H/SWEEP SEL to the 15 • 150 position. Readjust the

SWEEP VERNIER for two complete waveforms. The pulses should resemble those shown in Figures 3 and 4.

Alignment

The process of television-receiver alignment probably requires a greater amount of skill and understanding on the part of the service technician than does any other service function. Before undertaking alignment, it is important that the technician recognize the symptoms of a misaligned receiver.

The order in which various sections of the television receiver are aligned may differ between split-channel sound and intercarrier types. Different receivers of one system may also differ in the order of alignment. In all cases, however, the alignment order given by the manufacturer in his service notes should be followed.

For these reasons, it is not feasible to present a general alignment procedure applicable to all receivers. Some general precautions and suggestions for using the WO-33A Oscilloscope, however, are provided below to aid the television technician in servicing a receiver.

Receiver alignment requires, in addition to the WO-33A, a sweep generator, a marker generator of crystal accuracy, and a vacuum-tube voltmeter. An RCA WR-59 or WR-69-series Sweep Generator, an RCA WR-39, WR-99 or WR-89 Calibrator, and an RCA VoltOhmyst[®], such as the WV-77, WV-87, WV-97, or WV-98 are recommended.

Tuner Alignment — When preparing for tuner alignment, the manufacturer's recommendations should be followed closely. If the tuner has test points for connecting equipment, the test points should be used. The oscilloscope test point is usually connected internally to the mixer grid circuit where a demodulated signal is present.

The output cable of the sweep generator should be connected to the antenna input connectors. The ground lead of the WO-33A should be clipped directly to the tuner shield to minimize hum pickup on the sweep trace, and the WG-349A blue clip should be connected to the mixer grid-circuit test point. If no test point is provided, the WG-349A may usually be connected to the grid circuit through a 5,000 to 10,000-ohm composition resistor.

It is important that the WG-349A be connected directly to the proper test point or, if a series resistor is used, that the lead length between the probe clip and the mixer grid circuit be kept as short as possible to prevent hum pickup and possible distortion of the tuner curve on the WO-33A. Hum pickup is evidenced by twisting of the base line when return-trace blanking is used on the sweep generator. This precaution is necessary because of the high-gain level at which the WO-33A is operated for tuner alignment.

The INTENSITY control should be turned clockwise to obtain a trace of suitable brilliance. The vertical gain controls should be set for maximum or near maximum gain. The output from the sweep generator and marker calibrator should be set at a low level to avoid over-loading the TV receiver, distortion of the sweep curve, and an erroneous picture of alignment on the oscilloscope screen.

When the WO-33A is used with a sweep generator, it is important that the two instruments be adjusted so that blanking is correct and the sweep of both instruments is in phase. If the phase adjustment is not properly set before starting alignment, the sweep

[®]Trade Mark "VoltOhmyst" Reg. U. S. Pat. Off.

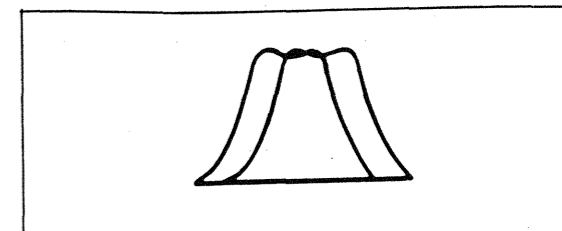

Figure 7. Double rf-response curve caused by improper setting of phasing control. No blanking used

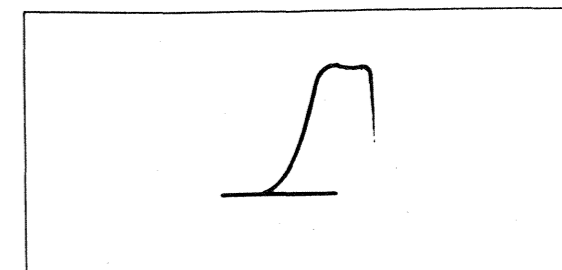

Figure 8. Sharp cutoff of response curve and misplaced base line with blanking indicate improper setting of phasing control

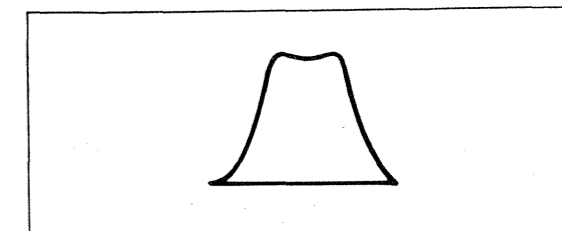

Figure 9. Typical rf-response curve

curve on the oscilloscope may be prematurely cut off or the curve may appear as a double or "mirror" image. These effects, shown in Figures 7 and 8, are sometimes misinterpreted as being caused by malfunctioning of test equipment although they may often be traced to improper tuner alignment.

The sweep generator may use either a sinusoidal or sawtooth sweep of line frequency. If a sinusoidal line-frequency sweep is used, the WO-33A may be driven internally by setting the H/SWEEP SEL control to "LINE". If a sawtooth sweep is used, the sweep generator deflection signal may be fed to the H INPUT terminal of the WO-33A. The H/SWEEP SEL should be set to "H IN". An internal sawtooth sweep may also be obtained by setting the H/SWEEP SEL to the 15 • 150 position.

If no blanking is used, the SYNC/PHASE control should be adjusted until the two response curves coincide on the oscilloscope screen. If blanking is used, the SYNC/PHASE control should be adjusted until the base line on the WO-33A screen extends the full width of the curve trace. An extremely sharp drop-off point on the response curve, which gives a "chopped-off" appearance to the trace short of the end of its sweep range, also indicates improper phasing. When a marker is superimposed on the response curve, improper phasing will cause two markers to appear on the curve. The SYNC/PHASE control should be adjusted to obtain the appearance of a single trace having only one marker. The setting of the SYNC/PHASE control is also important during sweep alignment of other sections of the receiver.

Serious misalignment of the tuner or considerable difficulty or failure in alignment may be caused by an unsuspected defective component. If proper alignment procedure fails to produce correct tuner curves, the technician should check individual components in the rf unit.

Picture-IF Alignment — To obtain an over-all picture-if response curve, the blue clip of the WG-349A probe should be connected across either the second detector load resistor or to the grid of the first video stage; test points which can provide a demodulated signal to the oscilloscope. The ground lead should be connected to the chassis. Because of the additional amplification in this section of the receiver, the oscilloscope gain should be considerably reduced, but not to the point where it is necessary to increase sweep-generator output.

Depending upon manufacturer's recommendations, it may be necessary to adjust the agc bias level, either through temporary wiring changes or by providing fixed battery bias. The service-notes should be followed closely because alignment procedure may involve considerable detail. Trap alignment is sometimes difficult because the marker disappears in the trap notch. This may often be overcome by magnifying the trap section of the trace with the V CAL and H GAIN controls.

Adjustment of the SYNC/PHASE control is also important when aligning the i-f sections of the receiver. The precautions and recommendations described under the section on tuner alignment, above, should be observed here. Controls on the WO-33A

should be set the same as for tuner alignment except that less vertical gain will be required.

For observation of the response of individual stages in the picture-if amplifier, the WG-350A Demodulator Probe^o should be used. This is a high-frequency rectifying-type probe. It is important that this probe be used properly and in accordance with service-note recommendations to prevent distortion of the response curve and an erroneous picture of alignment.

The WG-350A, which connects to the V INPUT of the WO-33A, is equipped with a short ground lead and clip. For alignment work, the ground clip of the probe should always be connected to ground near the test point being used for the WG-350A.

When the WG-350A is used to check individual stages, it should be connected on the output side of the stage being adjusted. For example, if the alignment of a coupling transformer is to be checked, the probe should be connected to the plate of the tube which has its grid coupled to the transformer. The tube thus acts as a buffer between the high-impedance grid circuit and the probe.

For general signal-tracing work, the probe may be moved from grid to grid throughout the i-f amplifier.

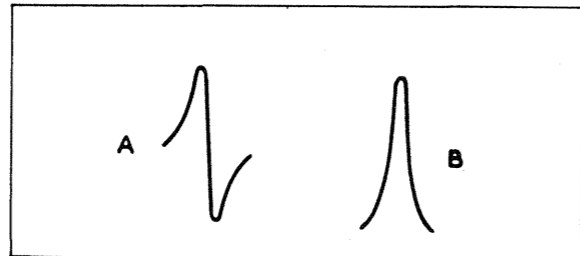

Figure 10. (A) Ratio-detector curve and (B) sound-if curve

Sound-IF and Detector Alignment — Most television receivers use either a discriminator or ratio detector. For either type, the WG-349A probe clip should be connected to the output of the sound detector. For detector alignment, the sweep and marker generators should be connected to the receiver as described in the service notes. An S-shaped curve, similar to that shown in Figure 10A, should be obtained on the oscilloscope screen. The setting of controls on the WO-33A should remain the same as before. A typical sound-if curve is shown in Figure

^oAvailable on separate order.

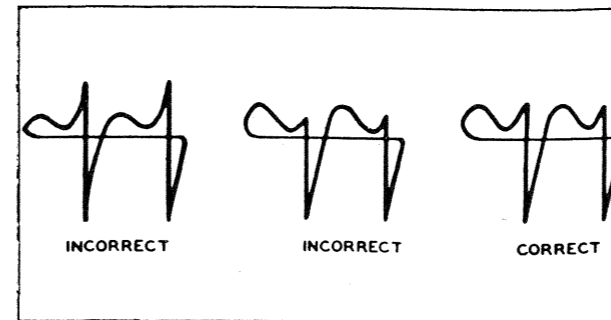

Figure 11. Horizontal-oscillator waveforms

10B. To obtain the sound-if response curve, the probe should be connected to either the grid-return of the limiter stage or to the grid-return of the last sound-if stage. The SYNC/PHASE control should be set no farther clockwise than necessary to lock in the waveshape.

Horizontal-Oscillator Adjustment — The WO-33A is well suited to adjustment of the horizontal oscillator and may be used as follows:

Set the H/SWEEP SEL control to the 1500 • 15 Kc position.

Adjust the SYNC/PHASE control to give stable lock-in of the waveshape, if necessary.

With the ground lead connected to the receiver chassis, connect the yellow clip of the WG-349A to the output of the horizontal oscillator, as described in the service notes. Connection to a typical horizontal-oscillator circuit is shown in Figure 12. Because the horizontal oscillator is a high-impedance circuit, the low-capacitance clip should always be used to reduce capacitance-resistance loading effects. Usually it is necessary to adjust the oscillator for suitable output waveshape. Typical horizontal-oscillator waveshapes which can be observed on the WO-33A are shown in Figure 13.

Sync-Separator Waveshape — To observe waveshapes in the sync-separator stage, the low-cap yellow clip should be used. Controls of the WO-33A should be set the same as for observation of the horizontal waveform. The probe clip should be connected to the plate of the sync separator or to the plate or grid of the sync amplifier.

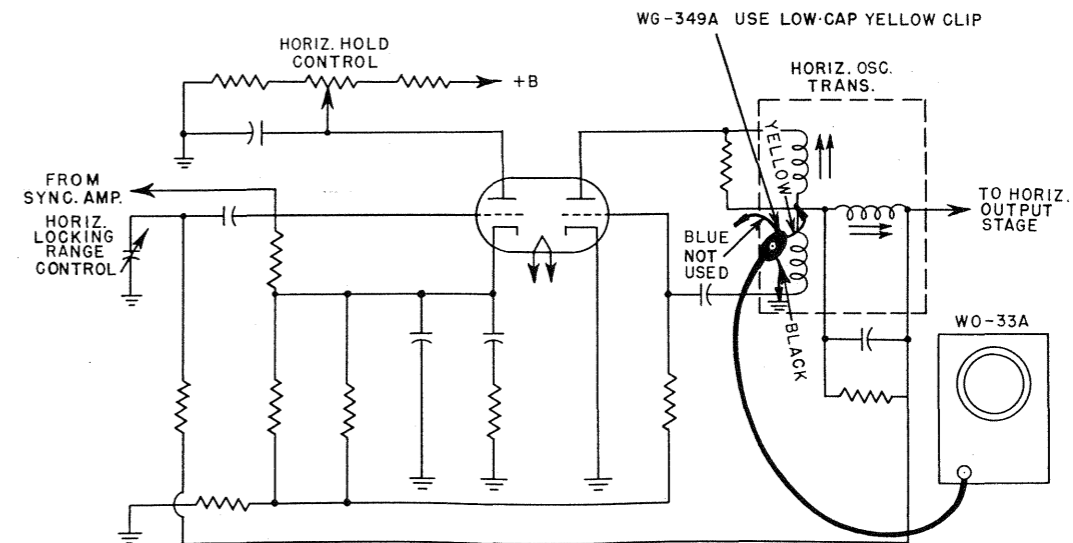

Figure 12. Adjustment of horizontal oscillator

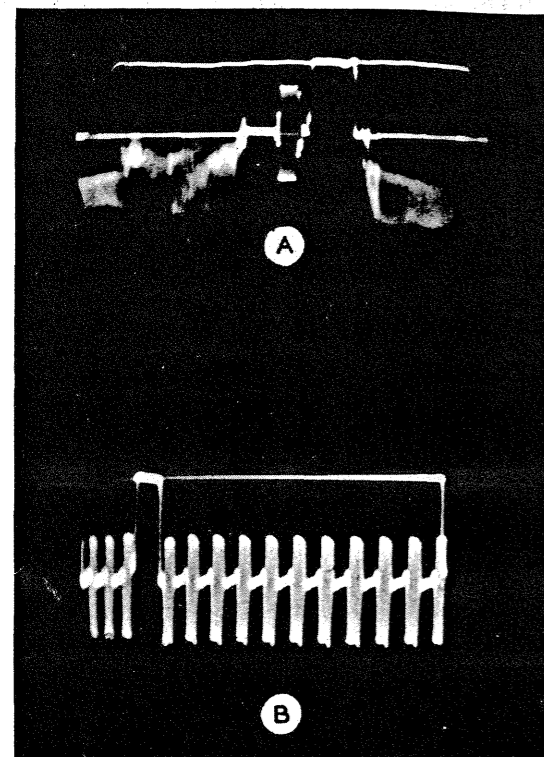

Figure 13. Color-TV signals as displayed by WO-33A. (A) Composite color-TV signal. Color-burst can be seen to left of sync pulse. (B) Output signal from RCA WR-61A Color-Bar Generator showing color-sync pulses and 10 color-bar pulses.

General Applications

Square-Wave Testing of Audio Amplifiers

The use of square waves for testing the characteristics of audio equipment has distinct advantages over other methods. A square-wave generator and the WO-33A Oscilloscope, when set up as shown in Figure 14, can provide a quick and accurate means of checking an amplifier and its adjustments. In this test setup, it is possible to check simultaneously the amplitude, phase, and frequency characteristics of the amplifier.

The value of the load resistance used depends upon the output impedance of the amplifier. It is important that the correct value be used. For an over-all check of amplifier response, the WO-33A should be connected directly across the load resistance, as shown.

It is desirable to employ square waves of at least two fundamental frequencies. The lowest fundamental frequency should be equal to approximately ten times the low-frequency limit of the amplifier being tested. A 100-cycle square wave should serve to check response from a few cycles to over 1000. If a square wave having a fundamental frequency of 2 Kc is used, the amplifier may be checked through the balance of the audible range.

The square-wave generator should be set to the proper frequency and connected to the regular input terminal of the amplifier. The WO-33A may be connected temporarily directly across the generator for a reference check of the waveform. The WO-33A may then be connected to various points in the amplifier to determine how each stage is functioning. The effect of various adjustments may be seen on the screen.

Care should be taken to prevent too large a signal from the square-wave generator from overloading the amplifier and causing distortion of the square wave.

Phase-Shift Measurements

To measure the phase shift of an audio network, apply a sine wave to the circuit under test and connect the direct probe to the output terminal of the network. This test signal should also be fed to the oscilloscope through the H INPUT and GND terminals. Set the H/SWEEP SEL control to the "H IN" position. If no phase shift exists, a sloping straight line will appear. Phase shift is indicated as an elliptical or circular trace. The method of calculating the degree of phase shift is shown graphically in Figure 16.

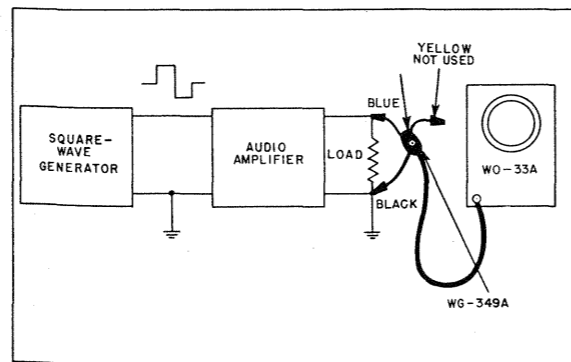

Figure 14. Audio amplifier test setup

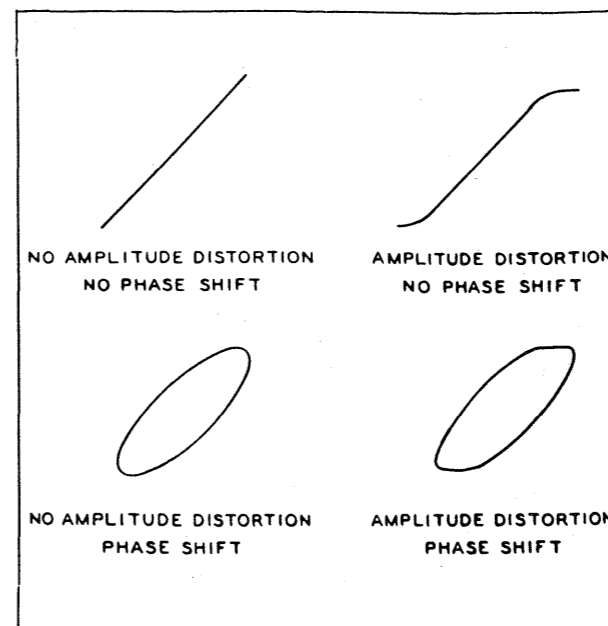

Figure 15. Distortion and phase shift in audio amplifier

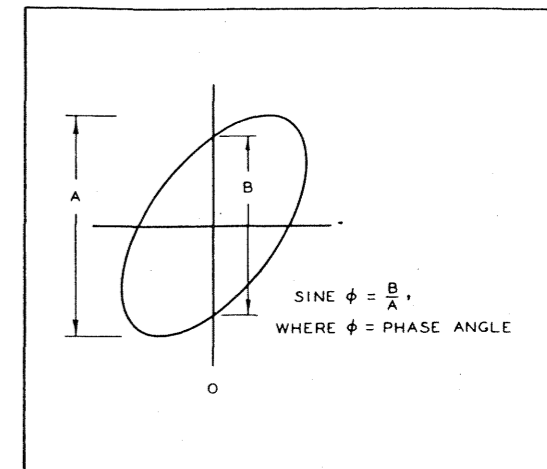

Figure 16. Measurement of phase shift

Frequency Measurements

Two methods may be used to determine frequency. In one method, a sine wave of known frequency is applied to the H INPUT terminal and the H/SWEEP SEL is set to "H IN". The unknown signal is fed to the V INPUT terminal. The resulting pattern, or Lissajous figure, indicates the ratio between the two frequencies. Typical Lissajous figures are shown in Figure 17.

In the other method of frequency measurement, the H/SWEEP SEL should be set at "LINE" to provide a sweep of line frequency. The signal of unknown frequency should be applied to the V INPUT terminal. If a stationary pattern is obtained on the oscilloscope screen, the frequency of the input signal must be equal to, a submultiple of, or a multiple of the line frequency.

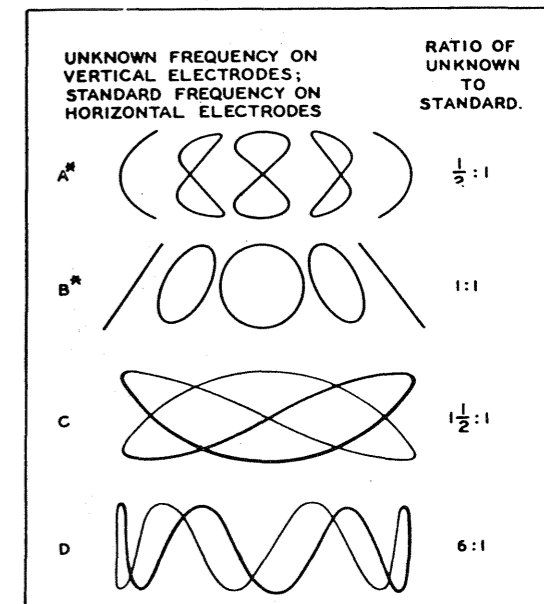

Figure 17. Lissajous figures

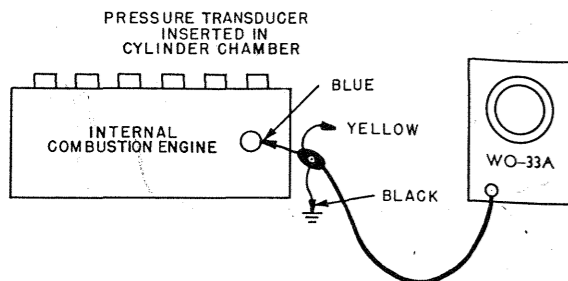

Figure 18. Engine-pressure analysis setup

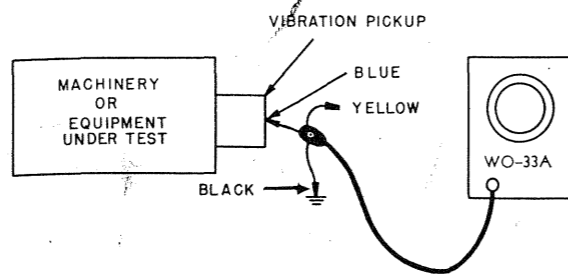

Figure 19. Vibration analysis setup

Industrial Applications

Use of the cathode-ray oscilloscope with a few auxiliary instruments has solved many perplexing problems both in the laboratory and in the service shop. The important applications of the oscilloscope are many. A few which serve to illustrate the wide range of possible applications are described below.

Engine-Pressure Analysis

When the WO-33A is used with auxiliary equipment such as is shown in Figure 18, variations in cylinder-head pressure developed in an internal-combustion engine or similar type machine can be

shown on the oscilloscope screen. The oscilloscope has proven useful in the development of internal-combustion engines when used with engine pressure-measuring devices.

Vibration Measurements

The WO-33A can also be used with a piezo-electric transducer or with the RCA type 5734 mechano-electronic transducer for measuring vibration. Figure 19 shows a typical setup for observing vibration waveforms, indicating relative amplitudes and other characteristics of vibration on the oscilloscope screen.

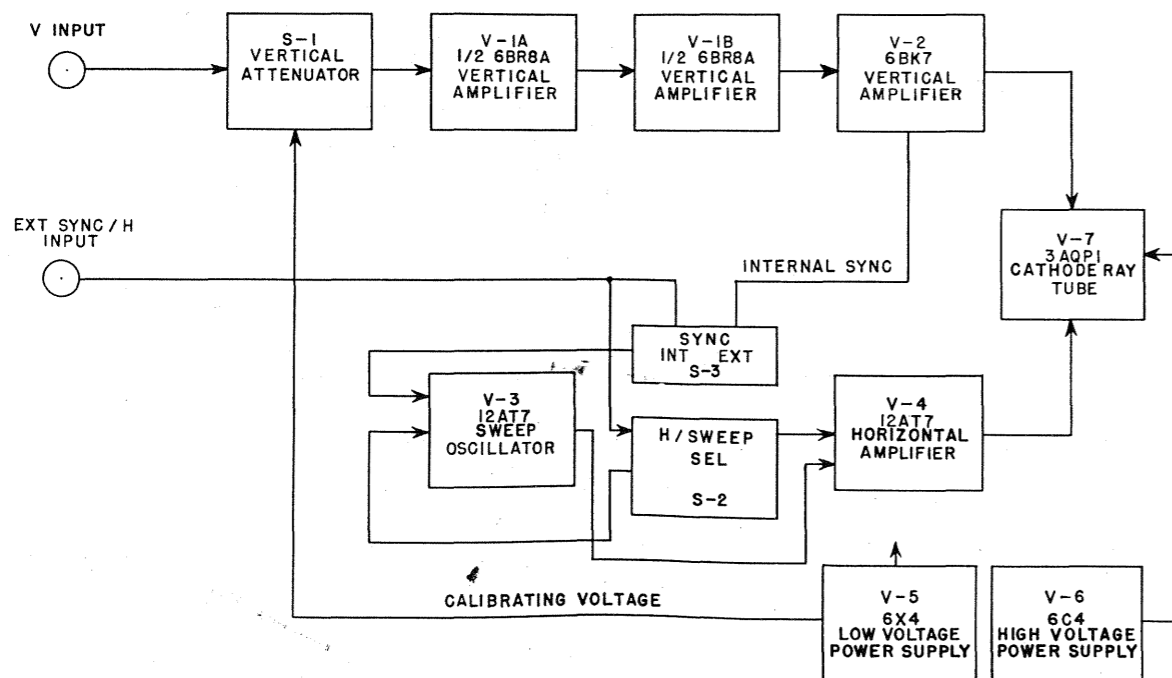

Figure 20. Block Diagram WO-33A

Maintenance

CAUTION: Do not strike or subject the cathode-ray tube to more than moderate pressure as breakage of the tube may result in injury from flying glass. When the case of the instrument is removed, high voltages are exposed and the safety precautions outlined on Page 2 should be observed.

General

Performance of the WO-33A depends upon the quality of the components employed. If it should be necessary to replace any of the component parts, only RCA replacement parts or equivalents of those shown in the Replacement Parts List of this instruction booklet should be used.

The chassis may be removed from the case by removing two screws on each side of the case, and three screws from the bottom of the case. The panel and chassis assembly may then be pulled forward and out of the case.

If any alignment adjustments are made, the line voltage should be 117 volts at 50-60 cps. If trouble is encountered, voltage readings should be taken and compared with the operating voltages shown on the schematic diagram. Conventional trouble-shooting techniques should be used to locate trouble. Resistance and continuity checks can then be made to isolate the defective section or stage.

Astigmatism Adjustment

1. Turn on the WO-33A and allow at least 15 minutes warm-up time.

2. Set the H/SWEEP SEL to "LINE", the bandwidth control to "CAL", and adjust the PHASE, V CAL, and H GAIN control for a circular pattern approximately one inch in diameter.

3. With a screw driver, adjust potentiometer R-68 for best possible focus at all points on the circle. R-68 is located on top of the chassis.

Vertical Attenuator Alignment

Alignment of the frequency-compensated step-attenuator requires the use of a square-wave or clipped sine-wave signal of about 1000 cps in frequency.

1. Connect the blue clip of the WG-349A probe and cable to the square wave source.

2. Set the V RANGE switch to 60.

3. Adjust the scope controls so that two square waves, about an inch high and two inches wide are displayed on the screen.

4. Adjust C-6 so that the square waves are flat-topped, without overshoot spikes or drooping corners.

5. Reset the V RANGE control to 20, and reset the amplitude of the square wave generator. Adjust C-5 as in "4" above.

6. Repeat this process for V RANGE positions 6 and 2. The desired trimmer capacitor can be identified on the range switch by touching it with the finger and noting the appearance of a random noise signal on the CRT screen.

7. Now connect the square wave generator to the yellow clip of the WG-349A probe and cable. With the V RANGE control on position 2, adjust capacitor C-1 for a flat top trace without overshoot spikes or drooping corners.

Internal Calibrator Control Adjustment

1. Connect an audio oscillator or square wave generator to the blue clip of the WG-349A probe and cable. Set the V RANGE control to position 2. Adjust the signal source for full scale deflection on the CRT.

2. Transfer the signal source to the yellow clip lead of the WG-349A probe, and rotate the V RANGE control to position .2, and adjust potentiometer R-11 for full screen deflection.

RCA Repair Service

RCA maintains a complete repair service for the adjustment, calibration, and maintenance of RCA test equipment. If it becomes necessary to service this equipment, the report forms enclosed in this booklet should be filled out as described. It is important that:

1. Test equipment be packed carefully.
2. A full description of the trouble be included in the report.

Attention to these details will help prevent damage in transit and delay in repairs.

SYMBOL NO.	DESCRIPTION	STOCK NO.	SYMBOL NO.	DESCRIPTION	STOCK NO.
CAPACITORS					
C1, C2, C4, C5, C6	Trimmer, 4-40 μ f, Arca No 422		R42	Carbon Film, 100 K, 1 W, 5%	
C2, C14, C17, C18, C32	Paper 0.1 μ f, \pm 20%, 400 V		R43	Variable, Dual Carbon, 1 M and 5 M, 1/2 W, 10%	219603
C8	Ceramic Disc, 22 μ f, \pm 5%, 500 V	219215	R44	Carbon Film, 270 K, 1/2 W, 5%	
C9	Ceramic Disc, 64 μ f, \pm 5%, 500 V	219214	R45	Carbon Film, 39 K, 1/2 W, 5%	
C10	Ceramic Disc, 140 μ f, \pm 5%, 500 V	219205	R46	Carbon Film, 2.7 M, 1/2 W, 5%	
C11	Ceramic Disc, 410 μ f, \pm 5%, 500 V	219206	R47	Carbon Film, 3.3 M, 1/2 W, 5%	
C12	Ceramic Disc, 1500 μ f, \pm 5%, 500 V	219207	R49, R52	Carbon Film, 2.4 K, 1/2 W, 5%	
C13	Ceramic Disc, 1200 μ f, \pm 5%, 500 V	219216	R50, R53	Composition, 10 M, 1/2 W, 10%	
C15, C21, C22	Ceramic Disc, 0.02 μ f, GMV, 400 V		R54	Variable Carbon, 50 K, 1/2 W, 20%	219599
C14	Ceramic Disc, 560 μ f, \pm 5%, 500 V	219208	R55, R56	Carbon Film, 120 K, 1/2 W, 5%	
C19	Ceramic Disc, 0.05 μ f, \pm 20%, 200 V	219213	R59, R62	Composition, 2.7 M, 1/2 W, 10%	
C20	Paper, 0.05 μ f, \pm 20%, 200 V		R60	Variable Carbon, 2 M, 1/2 W, 20%	219600
C23	Ceramic Disc, 5 μ f, \pm 20%, 150 V	104014	R63	Composition, 4.7 K, 1/2 W, 10%	
C24	Ceramic Tubular, 12 μ f, \pm 5%, 500 V		R64	Wire Wound, 1.5 K, 7 W, 10%, IRC Type PW7	219123
C25	Paper, 0.22 μ f, \pm 10%, 400 V		R65	Wire Wound, 2.5 K, 5 W, 10%, IRC Type PW5	219124
C26	Paper, 0.022 μ f, \pm 10%, 400 V		R66	Composition, 2.2 K, 1/2 W, 10%	
C27	Ceramic Disc, 2200 μ f, \pm 5%, 400 V	219209	R67	Carbon Film, 47 K, 1/2 W, 5%	
C28	Ceramic Disc, 220 μ f, \pm 5%, 400 V	219210	R68	Variable Carbon, 100 K, 1/4 W, 20%	219201
C29	Ceramic Disc, 15 μ f, \pm 5%, 500 V	219204	R69	Composition, 180 K, 1/2 W, 10%	
C30	Ceramic Disc, 180 μ f, \pm 10%, 200 V	219211	R71	Variable Carbon, 500 K, 1/2 W, 20%	219601
C31	Ceramic Disc, 150 μ f, \pm 10%, 200 V	219212	R72, R74	Composition, 120 K, 1/2 W, 10%	
C33, C34, C35, C42	Paper, 0.1 μ f, \pm 20%, 200 V		R73	Variable Carbon, 75 K, 1/2 W, 20%, (Includes AC Switch)	219602
C38, C39	Electrolytic: 4 Sections	219127	R75	Variable, Dual Carbon, 250 K and 250 K, 1/2 W, 20%	219604
C38A, C39A	10 μ f, +100%, -15%, 450 V		R76	Variable Carbon, 10 K, 1/4 W, 20%	219202
C38B, C39B	20 μ f, +100%, -15%, 450 V		R77	Composition, 100 K, 1/2 W, 10%	
C38C, C39C	20 μ f, +100%, -15%, 450 V		R78	Composition, 15 K, 1/2 W, 10%	
C38D, C39D	40 μ f, +100%, -15%, 400 V		R79	Carbon Film, 9 M, 1/2 W, 1%	59359
C34, C37, C41, C40	Ceramic Disc, 0.01 μ f, 20%, 500 V Paper, 0.5 μ f, GMV, 1000 V		R80	Composition, 820, 1 W, 10%	
RESISTORS					
R1	Carbon Film, 680 K, 1/2 W, 5%		COILS		
R2	Carbon Film, 910 K, 1/2 W, 5%		L1	Coil, Peaking, 20 μ H, 5%	219130
R3, R4, R13	Carbon Film, 1 M, 1/2 W, 5%		L2, L3	Coil, Peaking, 36 μ H, 5% (On Comp. Res., 10 K, 1/2 W, 20%)	219129
R5, R48, R51	Carbon Film, 15 K, 1/2 W, 5%		SWITCHES		
R6	Carbon Film, 470 K, 1/2 W, 5%		S1	Switch Rotary (V Range) 9 Positions, 4 Sections	219199
R7	Carbon Film, 110 K, 1/2 W, 5%		S2	Switch, Rotary (H/Sweep Sel.) 6 Positions, 5 Sections	219200
R8	Carbon Film, 33 K, 1/2 W, 5%		S3	Switch, DPDT (Sync) Stackpole Type 55-33	106478
R9, R26	Carbon Film, 10 K, 1/2 W, 5%		MISCELLANEOUS		
R10	Carbon Film, 820 K, 1/2 W, 5%		T1	Transformer, Power	219122
R11	Variable, Wire Wound, 5 K, 1.5 W, 20%, Wirt Type WC808	219121	ID1	Lamp, Pilot, No. 47	
R12	Composition, 8.2 K, 1 W, 10%		X1D-1	Lampholder and Jewel, Pilot, Dialco No. 755-621	57761
R14	Carbon Film, 100, 1/2 W, 5%			Socket, Tube Min. Ind. Hdwr. No. NPI6	
R15, R18, R25, R31	Carbon Film, 1.2 K, 1/2 W, 5%			Socket, Tube Min. Bakelite, 7 Pin, Eby No. 9727-73	
R16, R33, R38	Composition, 1 M, 1/2 W, 10%			Socket, CRT, Wafer Type, Ind. Hdwr. No. K32-12	
R17	Carbon Film, 120, 1/2 W, 5%			Panel, Front	219119
R19	Composition, 4.7 K, 1 W, 10%			Graph Screen	219258
R20, R21, R61, R70	Composition, 470 K, 1 W, 10%			Bezel, Graph Screen	219128
R22	Carbon Film, 220 K, 1/2 W, 5%			Board, Laminated Circuit	219203
R23	Carbon Film, 82 K, 1/2 W, 5%			Binding Post	212151
R24, R32	Carbon Film, 1.8 K, 1 W, 5%			Clamp, CRT, Paul and Beakman No. LB-150	
R27	Variable Carbon, 5 K, 1/2 W, 20%	219597		Connector, Miniature Microphone, Male, Electrocraft No. 453	
R28, R29	Carbon Film, 1 K, 1/2 W, 5%			Connector, Miniature Microphone, Female, Electrocraft No. 452	
R30	Wire Wound, 2.4 K, 5 W, 5%, IRC Type PW5	219125			
R34, R37, R57, R58	Carbon Film, 820 K, 1/2 W, 5%				
R35	Variable Carbon, 1 M, 1/2 W, 20%	219598			
R34	Composition, 1.2 M, 1/2 W, 10%				
R39	Composition, 68 K, 1/2 W, 10%				
R40	Composition, 3.3 K, 1/2 W, 10%				
R41	Carbon Film, 680, 1/2 W, 5%				

SYMBOL NO.	DESCRIPTION	STOCK NO.	SYMBOL NO.	DESCRIPTION	STOCK NO.
	Foot, Rubber, Atlantic India Rubber No. 16			Clip, Minigator, Mueller Elec No. 30	
	Grammet Rubber, Philo Rubber Sup No. 1181A			Insulator Mini-Clip, Mueller Elec. No. 32	
	Cord, Power, B & M Elec Corp. No. 3340-6			Shell, Probe (2 pieces)	219485
	Knob, Blue Plastic	59543		Handle, Black, Philo Brief Case No. 4603	219120
	Knob, Black Rubber	94878			

WARRANTY

Factory-Wired Instruments

Radio Corporation of America warrants its test and measuring equipment, when properly registered, against defects in workmanship, materials, and construction under normal use and service for a period of one year from the date of sale to original purchaser. Under this warranty, RCA's obligation is limited to repairing or replacing any defective parts except fuses, which are not covered by this warranty.

This warranty does not apply to any instrument which has been altered in an unauthorized manner, or which has been misused or damaged by accident or negligence, or which has had the serial number removed, altered or effaced.

RCA tubes and RCA batteries used in such equipment are covered by our standard tube or battery warranty. Secondary damage, caused by leaky batteries, is not covered by this warranty.

Kits

Radio Corporation of America warrants the parts (except fuses) supplied in its test instrument kits, when properly registered, to be free from defects under normal use and service for a period of three months from date of sale to original purchaser. Under this warranty, RCA's obligation is limited to repairing or replacing any such defective parts that are returned to its factory or authorized service depots.

This warranty is completely voided if acid-core solder or paste fluxes have been used in the wiring. Furthermore, RCA will not replace, repair, or service any kits thus mishandled.

RCA tubes and RCA batteries used in such equipment are covered by our standard tube or battery warranty. Secondary damage, caused by leaky batteries, is not covered by this warranty.

The facilities of RCA and its service depots are available to RCA's customers at a nominal fee for the repair of kit-instruments which have been *completely assembled* in accordance with RCA's assembly instructions. In the handling of such instruments, the service depots will adjudge the responsibility for the malfunctions found, and apportion the cost of repairs accordingly between RCA and the owners of the kit-instruments.

RADIO CORPORATION OF AMERICA

This warranty is valid only when the card enclosed with the instrument is properly filled in and returned for registration.

Devices or arrangements shown or described herein may use patents of RCA or others. Information contained herein is furnished without responsibility by RCA for its use and without prejudice to RCA's patent rights.